











# EW533ST

DLP® Projector

## Project in the smallest of spaces

-  Widescreen 64" image from just 1m away
-  Widescreen presentations and HD entertainment
-  3000:1 contrast ratio for sharp, detailed presentations and graphics
-  Bright projection – 2500 ANSI Lumens
-  Digital and Analogue connectivity includes: HDMI, VGA
-  Cable free presentations with wireless convenience
-  Low ownership costs – up to 5000hrs lamp life
-  10W speaker – all-in-one multimedia set-up
-  Portable – carry bag provided for easy transportation
-  Environmentally friendly design <1W standby mode
-  Optoma EW533ST filter-free design – virtually no maintenance



## Widescreen 64" image from just 1m away

Project in the smallest of rooms with the widescreen, HD Ready EW533ST. Installed or on the move, the versatile EW533ST incorporates extensive connectivity and powerful 10W stereo speakers. At 2500L, the EW533ST is easy to use and ensures crystal clear, bright projection for the best business and education presentations.

The environmentally friendly EW533ST has energy saving features including <1W standby mode and auto power off saving you both time and money. Long lamp life of 5000hrs combined with our unique Optoma Colour and Imager guarantees ensure hassle-free, long-lasting projection.

### SHORT THROW LENS

The EW533ST can project an impressive 64-inch diagonal image from just 1m from the screen. Stand-alone or ceiling mounted the EW533ST eliminates shadows on the screen and allows you to present with ease.

#### Current Projectors

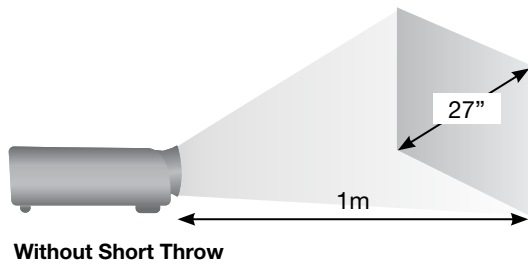

Without Short Throw

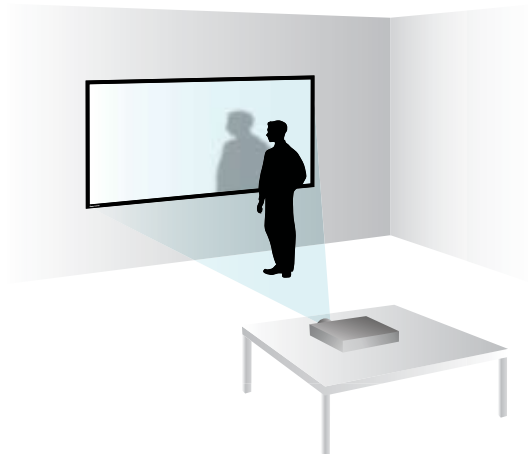

#### EW533ST – Shadow-free Images

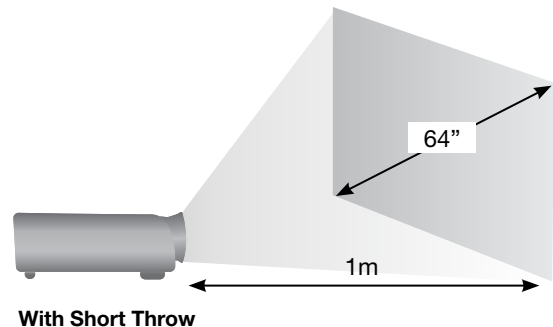

With Short Throw

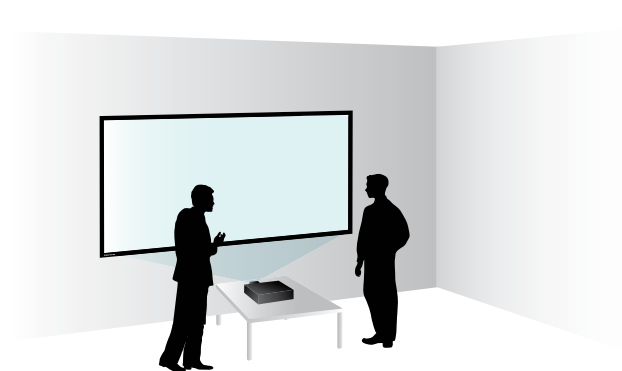

### WIRELESS PRESENTING (OPTIONAL EXTRA)

Making presentations couldn't be easier using the optional wireless features of the EW533ST. Cable free presenting saves time and facilitates effortless switching between presentations from different sources. Simply download the software and start presenting instantly. WPS-Dongle, lets you connect and display presentation material wirelessly.



## TRUE WXGA RESOLUTION

The EW533ST is the perfect companion for widescreen laptops. Your presentations will appear as sharp and detailed as they do on your widescreen laptop in WXGA (1280 x 800). WXGA resolution gives 30% more pixels than XGA.



XGA



WXGA

## TRUE HDMI

Project crystal clear images using the latest HDMI v1.3 input. Hassle-free projection from a widescreen computer/HD source with a single HDMI cable – no need for separate audio cables.

## CONTROL

The extensive RS232 command set makes it simple and easy to control the EW533ST with any control system.



AMX Compatibility – Dynamic Discovery Protocol is incorporated into the EW533ST. This feature allows for easy installation with AMX control systems.

## EXTENSIVE CONNECTIVITY

This native WXGA projector accepts a wide variety of computer and video input signals.

Connectivity includes: HDMI, VGA–Wireless/ Component, S-Video, Composite and RS232.

## CLEAR, FOCUSED IMAGES

DarkChip3™ technology from Texas Instruments produces a stunning 3000:1 contrast ratio for pin sharp graphics and crystal clear text. Crisper whites, ultra-rich blacks makes images come alive and text easier to read - ideal for business and education presentations.



1000:1 contrast ratio

3000:1 contrast ratio

\*Simulated Image

## AMAZING COLOURS

The EW533ST incorporates BrilliantColor™ technology to produce stunningly bright images with perfectly balanced life-like colours.

Preset display modes allow you to achieve a perfect image on a variety of surfaces including screens and interactive whiteboards.

## COLOUR AND IMAGER GUARANTEE

Bright colours and fantastic image quality are guaranteed for an amazing 5 years after purchase - giving piece of mind that the technology inside the Optoma EW533ST projector won't fade or degrade.



## VIRTUALLY MAINTENANCE FREE = LOWER COST OF OWNERSHIP

EW533ST provides lower cost of ownership, longer life and improved reliability. The filter-free projector design does not require regular filter cleaning or filter replacement, saving you time and money.



## ENVIROMENTALLY FRIENDLY

The EW533ST incorporates energy saving features to conserve power and extend the lamp life:



To achieve the maximum 5000hrs\*\* lamp life time the projector should be operating in STD mode and the shut down timer should be enabled to automatically switch off the projector if it is accidentally left on when no longer required. Enabling the <1W Standby mode will ensure the minimum energy consumption when the projector is not being used.



It takes less than 10 seconds for the projector to power up and shutdown, saving both time and energy.

## FEATURES

- 6 preset display modes
- Security bar and password protection for added security
- Easy to use remote with direct source selecting

## EW533ST SPECIFICATIONS

Native Resolution	WXGA 1280 x 800
Display Technology	Single 0.65" WXGA DC3 DMD chip DLP® Technology by Texas Instruments
Brightness - BRIGHT mode	2500 ANSI Lumens
Contrast	3000:1
Noise Level - STD mode	27dB
Lamp Life**	5000/3000 (STD/BRIGHT mode)
Projections Lens	F Number 2.55 Focus Length 10.19mm Focus / Zoom Type Manual Focus / 2.0x Digital Zoom Throw Ratio 0.72:1 (Projection Distance: Image Width)
Projection Distance	0.5 - 5m
Image Size	0.82 - 8.19m (32.24" - 322.41") Diagonal 16:10
Offset	112.4%
Weight / Dimensions (W x D x H)	2.9 kg / 324 x 234 x 97mm
Lamp Life*	5000/3000 (STD/BRIGHT mode)
Remote Control	Full function remote with direct source selecting
INPUTS	HDMI (HDCP) - audio supported 15 Pin D-Sub VGA (Wireless/Component via adaptor) S-Video 4 Pin Mini Din Composite RCA Stereo RCA-Audio video inputs
CONTROL	RS232 - 9 Pin D-sub
OUTPUT	Stereo Audio Mini Jack
Audio	10W Speaker
Aspect Ratio	16:10 Native, 16:9/4:3 Compatible
Keystone Correction	± 15° Vertical
On Screen Display	17 Languages: English, German, French, Italian, Spanish, Portuguese, Polish, Dutch, Russian, Finnish, Swedish, Greek, Norwegian/Danish, Hungarian, Czech, Turkish & Arabic
Compatible Resolutions	UXGA, SXGA, WXGA, HD, XGA, SVGA
Video Compatibility	PAL SECAM 576i/p, NTSC 480i/p, HD 720p/1080i/1080p
Uniformity	85%
Displayable Colours	1.07 Billion
Horizontal Scan Rate	15 - 91kHz
Vertical Scan Rate	25 - 120Hz
Power Supply	100 - 240V, 50 - 60Hz
Power Consumption	230W BRIGHT mode < 1W Standby mode 212W STD mode < 1W Standby mode**
Operating Conditions	Operating: 5 - 40°C, 85% Humidity (Max), 3000m Altitude (Max)
Security	Security Bar, Kensington Lock Port, Password Protection
Standard Accessories	Soft Carry Bag, Lens Cover, AC Power Cord, VGA Cable, Full Function Remote, Batteries x 2, Quick Start Guide, CD User Manual, Warranty Card, WEEE Card
Optional Accessories	Wireless Dongle, SCART & Component adapter, Ceiling Mount
RoHS	Compliant
Lamp Warranty	6 months or 1000 hours - whichever comes sooner
Warranty	Warranty may vary by country. Please see <a href="http://www.optomaeurope.com">www.optomaeurope.com</a> or ask your local supplier for details
Colour Guarantee*	5 Years
Imager Guarantee***	5 Years
3D Support	120Hz frame sequential 3D for resolutions up to 720p. 60Hz field sequential 3D for resolutions up to 480i
3D Viewing	Requires Optoma DLP® Link™ active shutter glasses - sold separately
3D Compatibility	The 3D features of the EW533ST can only be used with compatible 3D content and do not support 3D TV broadcast systems, including the 3D SKY service in the UK, or 3D Blu-ray. Support for these applications may be added in future using additional hardware

## EASY TO USE REMOTE CONTROL

### EW533ST Remote Control

- 1 Vertical Keystone Correction
- 2 Volume Control
- 3 Brightness Adjustment
- 4 AV Mute
- 5 Direct Input Source Selection

### EW533ST Connections

- 6 HDMI (audio supported)
- 7 VGA In - Wireless & Component
- 8 S-Video
- 9 Composite Video
- 10 Audio Out
- 11 RS232
- 12 Audio In
- 13 Kensington™ Lock
- 14 Security Bar



### Exceptional Connectivity/ Multiple Terminals



Easy to use remote with buttons to change the input sources



### EW533ST Projection Distance 0.5 - 5.0m (16:10 Aspect Ratio)

Projection Distance (m)	Horizontal Image Size (m)	Vertical Image Size (m)	Diagonal Image Size (m)	Diagonal Image Size (inch)	Image Offset (m)
0.50	0.69	0.43	0.82	32.24	0.05
0.70	0.97	0.61	1.15	45.14	0.08
0.80	1.10	0.69	1.30	51.26	0.09
0.90	1.25	0.78	1.47	58.03	0.10
1.00	1.39	0.87	1.64	64.48	0.11
1.50	2.08	1.30	2.46	96.72	0.16
2.00	2.78	1.74	3.28	128.96	0.22
2.50	3.47	2.17	4.09	161.21	0.27
3.00	4.17	2.60	4.91	193.45	0.32
3.50	4.86	3.04	5.73	225.69	0.38
4.00	5.56	3.47	6.55	257.93	0.43
4.50	6.25	3.91	7.37	290.17	0.48
5.00	6.94	4.34	8.19	322.41	0.54

For guide purposes only

EW533ST is capable of 4:3 and 16:9 aspect ratio projection. When projecting a 4:3/16:9 image the image sizes, screen height and offset information will differ from the above.

**Optoma Europe Ltd.**  
42 Caxton Way, Watford Business Park, Watford, Hertfordshire, UK. WD18 8QZ  
[www.optoma.co.uk](http://www.optoma.co.uk)

**Panoview**  
Optoma recommended Screens  
[www.panoview.eu](http://www.panoview.eu)



\*Optoma guarantees that in normal use, Optoma DLP® colour quality will be indistinguishable from when new. Please note that worn lamps will give slight variance. Exclusions: (1) Guarantee is voided if the projector is subject to damage through mis-use. (2) Guarantee may be void in industrial or commercial entertainment environments where dust or smoke is particularly excessive. (3) Guarantee will not apply if lamp brightness is below 50% due to wear or if the projector is not working due to other fault. \*\*Typical lamp life achieved through testing. Will vary according to operational use and environment conditions. \*\*\* Optoma guarantees that in normal use, the DLP® imager guarantee will retain quality for at least 5 years providing consistent pixel performance. Exclusions: (1) Guarantee is voided if the projector is subject to damage through mis-use. (2) Guarantee may be void in industrial or commercial entertainment environments where dust or smoke is particularly excessive. Copyright © 2010, Optoma Europe Ltd. All other product names and company names used herein are for identifications purposes only and may be trademarks or registered trademarks of their respective owners. Errors and omissions excepted, all specifications are subject to change without notice. DLP®, BrilliantColor™ and the DLP logo are registered trademarks of Texas Instruments.